



# **Residential and Commercial Custom Products**

## **List Prices CLP-1**

Effective July 11, 2011  
Supercedes CUSL-32 and CS-4

**ELKAY POINTS OF SUPERIORITY**

1. Elkay "Lusterton" Custom Cabinet Sink and Countertops are fabricated of #18 gauge nickel bearing (18-8, Type 304) stainless steel bonded to, and reinforced with, #14 gauge steel plate and 3/4"x3/4"x1/8" angle iron.
2. Intersections where sink bowls meet drainboards are rounded to sanitary radii.
3. Drainboard, sink bowls, raised rims and backsplash are welded, ground and polished smooth to a one-piece seamless appearance.
4. All corners in sink bowls (horizontal and vertical) are rounded to 1 3/4-inch radii.
5. Drainboards have large, fan-shaped areas pitched to drain. To incorporate pitch, drainboard must be minimum 15" long.
6. Entire underside of sink top and bowl is fully undercoated to dampen sound and prevent condensation.
7. Superior surface finish and satin luster achieved through special hand polishing operations by master craftsmen.

**HOW TO MEASURE**

1. Measure, in inches, along wall or walls where top is to be installed.
2. Establish overall counter width, front to back, (standard is 25"), including backsplash thickness.
3. Determine height of backsplash (measured from top of raised rim.)\* (Standard is 4") Determine thickness of backsplash, (Standard is 1 1/2").
4. Determine sink bowl size and its location. (See pages 4 and 5.)
5. List special features such as range cutout, return ends, rounded corners, etc. (See pages 6 and 7.)

**\* Explanatory Note:**

Elkay Custom Sink Tops and Countertops are provided with our standard 5/32" raised rim. Flat rim is available at no additional charge. For rims other than 5/32" or flat, please refer to Custom Feature #17 on page 7.

**HOW TO ORDER**

1. When ordering Elkay custom made stainless steel sink and countertops, accuracy of dimensions is of the utmost importance.
2. Furnish a sketch of sink or counter arrangement marked with proper dimensions, and special features. **Remember, you cannot give too much information.**
3. Always include the following information:
  - a) Show dimension from end of counter to **center line** of single compartment sink models...or
  - b) Show dimension from end of counter to center line of partitions of two or more compartment sink models.
  - c) Specify model number of faucet and other trim desired, if not included with the sink model chosen.
  - d) Indicate manufacturer's name and complete model number of range unit to be installed if applicable.
  - e) Indicate and locate all cutouts or special conditions you require. (See pages 6 & 7.)

**HOW TO PRICE**

**For Basic Counter Tops up to 25" wide**

1. Add all wall dimensions to determine total linear inches of counter. From Schedule for Countertops on page 3 locate total inches column one. Under proper backsplash height column, read total price of basic counter.
2. When sink bowl is desired, add to price of basic counters, the price of sink model chosen, as shown on pages 4 and 5 (custom sizes are available).
3. Add the price of all special features applicable, as shown on pages 6 and 7.

**Illustration A**

Limitation profile of sink when wall faucets are used.

Limitation profile of sink when deck faucets are used.

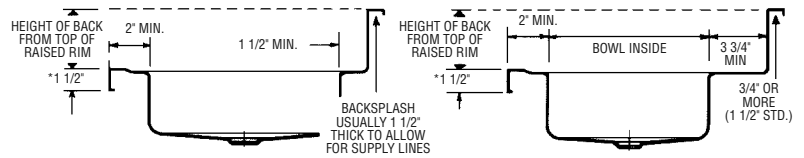

\* 1 1/4" top thickness can be furnished when specified at no additional cost.

**Illustration B**

Underside view of construction detail

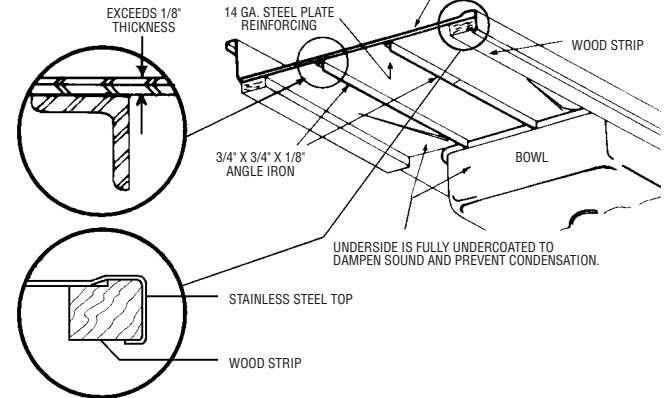

**Illustration C**

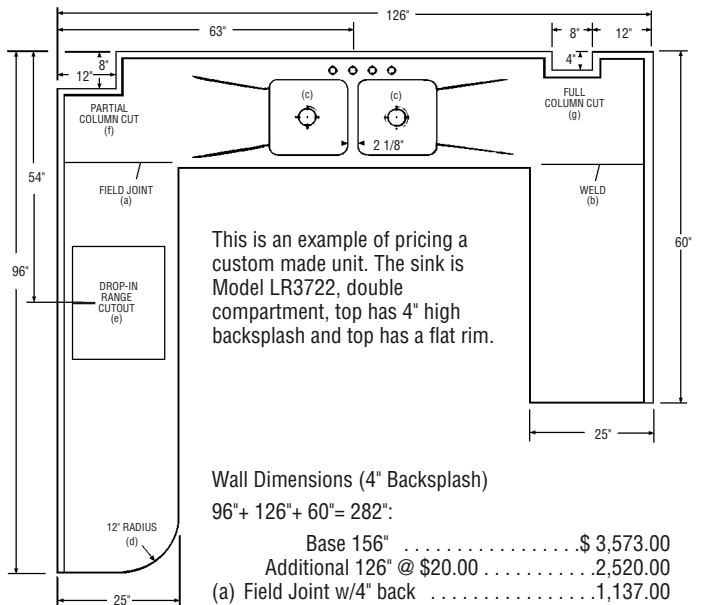

This is an example of pricing a custom made unit. The sink is Model LR3722, double compartment, top has 4" high backsplash and top has a flat rim.

**Wall Dimensions (4" Backsplash)**

96" + 126" + 60" = 282":

Base 156" .....	\$ 3,573.00
Additional 126" @ \$20.00 .....	2,520.00
(a) Field Joint w/4" back .....	1,137.00
(b) "U" Weld w/4" back .....	909.00
(c) LR3722 Double Bowl .....	2,042.00
(d) 12" Radius Calculations	
Base 3" .....	170.00
Additional 9" @ \$29.00 .....	306.00
(e) Range Cutout .....	382.00
(f) Partial Column Cut .....	392.00
(g) Full Column Cut .....	992.00
<b>TOTAL LIST PRICE .....</b>	<b>\$12,423.00</b>

- List prices on this page cover countertops only.
- For in-between sizes use price of next longer size.
- Length, inches are total wall measurement (straight, L or U shape).
- Prices shown are for countertops up to 25" wide.  
For tops over 25" wide, see Illustration D.
- Pages 4 and 5 show sink bowls and list prices.
- Pages 6 and 7 show prices for additional custom features.

### SCHEDULE FOR COUNTERTOPS

Length in Inches	BACKSPLASH HEIGHTS				
	No Back	4" Back	8" Back	12" Back	16" Back
15"	\$ 536.00	\$ 582.00	\$ 620.00	\$ 649.00	\$ 690.00
18"	602.00	652.00	697.00	734.00	787.00
21"	668.00	723.00	774.00	822.00	880.00
24"	734.00	790.00	850.00	907.00	975.00
27"	800.00	860.00	927.00	996.00	1,071.00
30"	867.00	928.00	1,005.00	1,081.00	1,167.00
33"	974.00	999.00	1,082.00	1,166.00	1,298.00
36"	1,046.00	1,066.00	1,160.00	1,254.00	1,393.00
39"	1,064.00	1,136.00	1,214.00	1,340.00	1,488.00
42"	1,106.00	1,206.00	1,314.00	1,426.00	1,582.00
45"	1,153.00	1,275.00	1,390.00	1,513.00	1,678.00
48"	1,198.00	1,344.00	1,467.00	1,598.00	1,772.00
51"	1,243.00	1,412.00	1,544.00	1,686.00	1,868.00
54"	1,287.00	1,483.00	1,621.00	1,771.00	1,963.00
57"	1,353.00	1,552.00	1,699.00	1,857.00	2,059.00
60"	1,413.00	1,618.00	1,777.00	1,945.00	2,152.00
63"	1,444.00	1,689.00	1,854.00	2,031.00	2,247.00
66"	1,474.00	1,759.00	1,930.00	2,118.00	2,344.00
69"	1,593.00	1,827.00	2,008.00	2,203.00	2,439.00
72"	1,654.00	1,896.00	2,084.00	2,290.00	2,534.00
75"	1,714.00	1,958.00	2,162.00	2,379.00	2,631.00
78"	1,773.00	2,036.00	2,239.00	2,466.00	2,730.00
81"	1,836.00	2,104.00	2,316.00	2,552.00	2,853.00
84"	1,896.00	2,173.00	2,394.00	2,640.00	2,926.00
87"	1,978.00	2,242.00	2,470.00	2,726.00	3,025.00
90"	2,059.00	2,312.00	2,546.00	2,812.00	3,118.00
93"	2,139.00	2,382.00	2,624.00	2,905.00	3,224.00
96"	2,220.00	2,449.00	2,701.00	2,998.00	3,327.00
99"	2,302.00	2,518.00	2,778.00	3,092.00	3,428.00
102"	2,368.00	2,587.00	2,854.00	3,183.00	3,530.00
105"	2,434.00	2,656.00	2,931.00	3,277.00	3,632.00
108"	2,502.00	2,727.00	3,009.00	3,370.00	3,733.00
111"	2,569.00	2,796.00	3,087.00	3,463.00	3,835.00
114"	2,636.00	2,865.00	3,164.00	3,556.00	3,936.00
117"	2,702.00	2,932.00	3,241.00	3,649.00	4,039.00
120"	2,769.00	3,002.00	3,319.00	3,750.00	4,146.00
123"	2,835.00	3,070.00	3,396.00	3,849.00	4,251.00
126"	2,902.00	3,141.00	3,472.00	3,949.00	4,358.00
129"	2,970.00	3,210.00	3,549.00	4,047.00	4,464.00
132"	3,037.00	3,278.00	3,626.00	4,148.00	4,569.00
135"	3,103.00	3,348.00	3,703.00	4,249.00	4,677.00
138"	3,170.00	3,417.00	3,781.00	4,348.00	4,783.00
141"	3,236.00	3,486.00	3,858.00	4,448.00	4,890.00
144"	3,304.00	3,556.00	3,934.00	4,545.00	4,995.00
147"	3,370.00	3,624.00	4,011.00	4,646.00	5,103.00
150"	3,438.00	3,694.00	4,088.00	4,746.00	5,209.00
153"	3,505.00	3,762.00	4,166.00	4,846.00	5,314.00
156"	3,573.00	3,831.00	4,243.00	4,946.00	5,420.00
Over 156" add for each inch*	22.00	24.00	25.00	33.00	36.00
*Extra charge for length weld for Tops over 156" long	814.00	909.00	1,130.00	1,202.00	1,299.00
Approx. ship wt. per linear foot	22#	24#	26#	28#	30#

\* Note: For dimensions in fractions of an inch, round up to next full inch to calculate price.

Illustration D

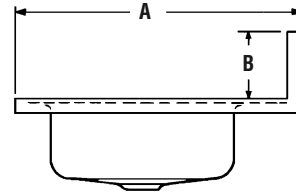

**For Tops Exceeding 25" Wide**

For sink and/or countertops wider than 25"...

add the desired width of top (A) to height of back (B) and use following:

- a) When total of A plus B is 29" or less, **use price column under 4" back.**
- b) When total of A plus B is over 29" to 33" inclusive, **use price column under 8" back.**
- c) When total of A plus B is over 33" to 37" inclusive, **use price column under 12" back.**
- d) When total of A plus B is over 37" to 41" inclusive, **use price column under 16" back.**

Illustration E

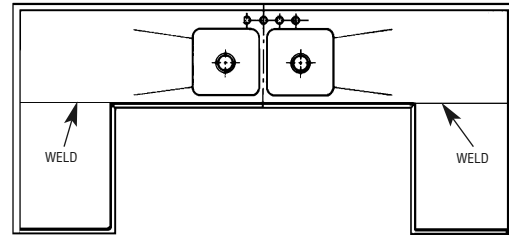

**For welded one piece tops... "L" or "U" shapes.**

In pricing tops use full wall dimensions and add for each weld as follows:

- Unit with no back (up to 25" wide) add ..... \$ 814.00
- Unit with 4" back or less add ..... 909.00
- Unit with back over 4" add ..... 1,130.00

Illustration F

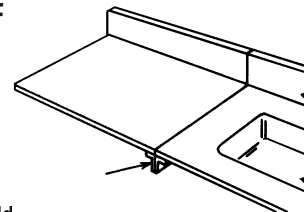

**For tops with field joint**

(For site assembly)

For straight, "L" or "U" shaped units requiring field joint (because of structural limitations) add for each field joint:

- Unit with no back (up to 25" wide) add ..... \$ 868.00
- Unit with 4" back or less add ..... 1,137.00
- Unit with back over 4" add ..... 1,420.00

## CONVENTIONAL SINKS

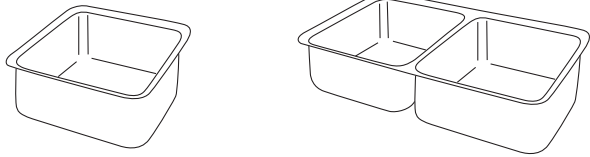

### SINGLE COMPARTMENT

MODEL NUMBERS	INSIDE COMPARTMENT SIZE			LIST PRICE
	LENGTH	WIDTH	DEPTH	
LMR2013	7 1/2	15 3/4	5 1/2	<b>\$ 943.00</b>
LR1522	11 1/2	16	7	<b>943.00</b>
BLR15	12	9 1/4	6 1/2	<b>943.00</b>
LR1517	12	12	7	<b>943.00</b>
*	12	14	7	<b>943.00</b>
LR1722	13 1/2	16	7	<b>943.00</b>
LR1716	14	10	7	<b>943.00</b>
LR1720	14	14	7	<b>943.00</b>
LR2022	16	16	7	<b>1,021.00</b>
LR2219	18	14	7	<b>1,021.00</b>
*	18	20	7	<b>1,155.00</b>
LR2222	19	16	7	<b>1,087.00</b>
LR2522	21	15 3/4	7 1/4	<b>1,155.00</b>
*	22	16	7	<b>1,155.00</b>
*	24	18	7	<b>1,303.00</b>
LR3122	28	16	7	<b>1,303.00</b>

### DOUBLE COMPARTMENT

MODEL NUMBERS	COMPARTMENTS OVERALL	INSIDE COMPARTMENT SIZE			LIST PRICE
		LENGTH	WIDTH	DEPTH	
*	17 1/8	7 1/2	15 3/4	5 1/2	<b>\$1,888.00</b>
LR2922	25 1/8	11 1/2	16	7	<b>1,888.00</b>
*	26 1/8	12	9 1/4	6 1/2	<b>1,888.00</b>
LR2918	26 1/8	12	12	7	<b>1,888.00</b>
*	26 1/8	12	14	7	<b>1,888.00</b>
LR3322	29 1/8	13 1/2	16	7	<b>1,888.00</b>
*	30 1/8	14	10	7	<b>1,888.00</b>
LR3319	30 1/8	14	14	7	<b>1,888.00</b>
*	34 1/8	16	11 1/2	7	<b>1,888.00</b>
LR3722	34 1/8	16	16	7	<b>2,042.00</b>
*	38 1/8	18	14	7	<b>2,042.00</b>
LR4322	40 1/8	19	16	7	<b>2,175.00</b>
*	44 1/8	21	15 3/4	7 1/4	<b>2,310.00</b>
*	46 1/8	22	16	7	<b>2,310.00</b>
*	50 1/8	24	18	7	<b>2,604.00</b>
*	58 1/8	28	16	7	<b>2,604.00</b>

## DEEP SINKS

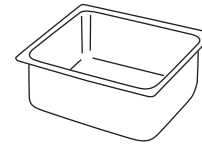

### SINGLE COMPARTMENT

MODEL NUMBERS	INSIDE COMPARTMENT SIZE			LIST PRICE
	LENGTH	WIDTH	DEPTH	
*	11 1/2	16	9 1/2	<b>\$1,122.00</b>
*	11 1/2	16	11	<b>1,210.00</b>
*	12	9 1/4	9 1/2	<b>1,122.00</b>
*	12	9 1/4	11 1/2	<b>1,210.00</b>
*	12	12	9 3/4	<b>1,122.00</b>
*	12	12	11 1/2	<b>1,210.00</b>
*	12	14	9 1/2	<b>1,122.00</b>
*	12	14	11 1/2	<b>1,210.00</b>
DLR172210	13 1/2	16	9 1/2	<b>1,185.00</b>
*	13 1/2	16	11 1/2	<b>1,274.00</b>
*	14	10	9 1/2	<b>1,122.00</b>
*	14	14	9 1/2	<b>1,185.00</b>
*	14	14	11 1/2	<b>1,274.00</b>
*	16	16	9 1/2	<b>1,250.00</b>
*	16	16	11 1/2	<b>1,339.00</b>
*	18	14	9 1/2	<b>1,250.00</b>
*	18	14	11 1/2	<b>1,339.00</b>
*	18	20	9 1/2	<b>1,386.00</b>
*	18	20	11 1/2	<b>1,477.00</b>
DLR222210	19	16	9 1/2	<b>1,329.00</b>
DLR222212	19	16	11 1/2	<b>1,418.00</b>
DLR252210	21	15 3/4	9 1/2	<b>1,386.00</b>
DLR252212	21	15 3/4	11 1/2	<b>1,477.00</b>
*	22	16	9 1/2	<b>1,386.00</b>
*	22	16	11 1/2	<b>1,477.00</b>
*	24	18	9 1/2	<b>1,479.00</b>
*	24	18	11 1/2	<b>1,582.00</b>
*	28	16	9 1/2	<b>1,479.00</b>
DLR312212	28	16	11	<b>1,582.00</b>

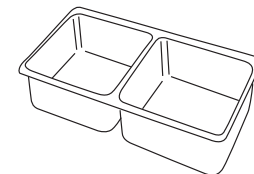

### DOUBLE COMPARTMENT

MODEL NUMBERS	COMPARTMENTS OVERALL	INSIDE COMPARTMENT SIZE			LIST PRICE
		LENGTH	WIDTH	DEPTH	
DLR332210	29 1/8	13 1/2	16	9 1/2	<b>\$2,368.00</b>
DLR332212	29 1/8	13 1/2	16	11 1/2	<b>2,546.00</b>
*	58 1/8	28	16	11	<b>2,958.00</b>

NOTE: MODELS SHOWN ABOVE WITH ASTERISK (\*) SHOULD BE SPECIFIED/ORDERED STATING COMPARTMENT SIZE.

### SPECIAL INFORMATION

(Prices for Bowls other than Shown – Available on Request)

Above sink compartments with 3 1/2" diameter hole in center (except for BLR15). For drain outlet other than 3 1/2" or off-center, PRICE ON APPLICATION.

\*Special Depths:

- a. For sink compartment depth over 3" to 7 1/2", use same price as 7 1/2" depth, above.
- b. For sink compartment depth over 7 1/2" to 10" use same price as 10" depth, above.
- c. For sink compartment depth over 10" to 12" use same price as 12" depth, above.

The above listing represents standard die-drawn sinks. These have lower prices and shorter lead times than custom-fabricated sizes.

The above bowls can be rotated 90° from above lengths and widths when required.

Custom-fabricated bowl sizes are available. Contact your Elkay sales representative for more information.

Please see pages 6 and 7 for custom features available for sink tops.

### WASTE-ALL SINKS

LWR3322R

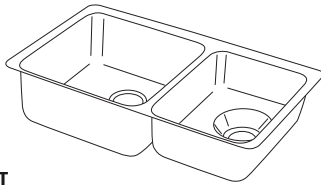

#### SINGLE COMPARTMENT

MODEL NUMBERS	INSIDE COMPARTMENT SIZE			LIST PRICE
	LENGTH	WIDTH	DEPTH	
LWR2522R or L	22	16	5 1/4	<b>\$1,431.00</b>

#### DOUBLE COMPARTMENT

MODEL NUMBERS	COMPARTMENTS OVERALL	REGULAR COMPARTMENT						WASTE-ALL COMPARTMENT			LIST PRICE
		LENGTH	WIDTH	DEPTH	LENGTH	WIDTH	DEPTH	LENGTH	WIDTH	DEPTH	
LWR3322R or L	29 5/8	16	16	7	11 1/2	16	5 1/2	5 1/2	5 1/2	<b>\$2,239.00</b>	

"R" or "L" Suffix... Use R (right) or L (left) to indicate location of Waste-All compartment

### CUISINE CENTRE

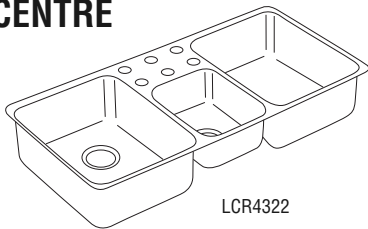

LCR4322

#### TRIPLE COMPARTMENT

MODEL NUMBER	COMPART. OVERALL	LENGTH IS LEFT TO RIGHT - WIDTH IS FRONT TO BACK												LIST PRICE
		INSIDE EACH COMPARTMENT						INSIDE EACH COMPARTMENT						
		LEFT L	LEFT W	LEFT D	CENTER L	CENTER W	CENTER D	RIGHT L	RIGHT W	RIGHT D	RIGHT L	RIGHT W	RIGHT D	
LCR4322	41 1/2	14	18	7 1/4	9 1/4	12	5 1/2	14	18	7 1/4	14	18	7 1/4	<b>\$3,444.00</b>

### OVAL AND ROUND BOWLS

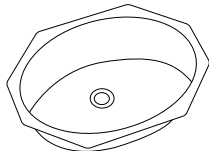

ELU1511

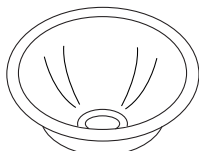

ELU9

#### OVAL BOWLS (INCL. OVERFLOW)

MODEL NUMBERS	INSIDE COMPARTMENT SIZE			LIST PRICE
	LENGTH	WIDTH	DEPTH	
LLVR1310	13 5/8	10 1/8	5 13/16	<b>\$ 921.00</b>
ELU1511	15 1/2	11 3/8	6	<b>996.00</b>

#### ROUND BOWLS

MODEL NUMBERS	INSIDE DIAMETER	DEPTH	LIST PRICE
ELU9	9" ROUND	4 3/4	<b>\$ 806.00</b>
ELU12	12" ROUND	6	<b>847.00</b>
ELU12LV	12" ROUND W/OF	6	<b>885.00</b>
ELU12FB	12" ROUND FB	6	<b>1,032.00</b>
ELU16	16" ROUND	8	<b>1,197.00</b>
ELU16LV	16" ROUND W/OF	8	<b>1,050.00</b>
ELU16FB	16" ROUND FB	8	<b>1,210.00</b>
LLVR19	14" ROUND W/OF	7	<b>921.00</b>

#### SPECIAL INFORMATION

(Prices for Bowls other than Shown - Available on Request)

Above sink compartments with 3 1/2" diameter hole (except for oval, round, and ELU1111). For drain outlet other than 3 1/2", PRICE ON APPLICATION.

\*Special Depths:

- For sink compartment depth over 3" to 7 1/2", use same price as 7 1/2" depth, above.
- For sink compartment depth over 7 1/2" to 10" use same price as 10" depth, above.
- For sink compartment depth over 10" to 12" use same price as 12" depth, above.

### SINKS AND TRAY COMBINATION

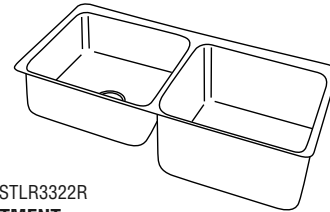

STLR3322R

#### DOUBLE COMPARTMENT

MODEL NUMBERS	COMPARTMENTS OVERALL	COMPARTMENT SIZE						LIST PRICE		
		REGULAR			DEEP					
L	W	D	L	W	D	L	W	D		
STLR3322R or L	29 1/8	13 1/2	16	7	13 1/2	16	9 1/2	16	9 1/2	<b>\$2,130.00</b>
STLR4322R or L	40 1/8	19	16	7	19	16	9 1/2	16	9 1/2	<b>2,418.00</b>

"R" or "L" Suffix... Use R (right) or L (left) to indicate location of extra deep compartment.

### OFFSET BOWLS

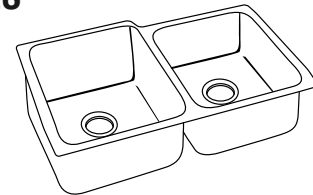

LR250

#### DOUBLE COMPARTMENT

MODEL NUMBERS	COMPARTMENTS OVERALL	COMPARTMENT SIZE						LIST PRICE		
		LEFT			RIGHT					
L	W	D	L	W	D	L	W	D		
LR250	29 5/8	14	18	7 1/4	13 1/2	16	7 1/4	13 1/2	16	<b>\$2,434.00</b>

### GOURMET BOWLS

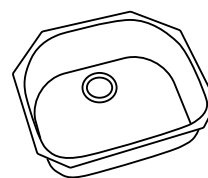

ELU2118

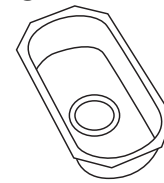

ELU715

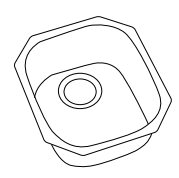

ELU1113

MODEL NUMBERS	INSIDE COMPARTMENT SIZE			LIST PRICE
	LENGTH	WIDTH	DEPTH	
ELU714	7	14 1/8	5 9/16	<b>\$1,122.00</b>
ELU715	7 1/2	15 3/4	5	<b>943.00</b>
ELU1111	11 1/2	11 1/2	6 3/8	<b>1,760.00</b>
ELU1113	11 3/4	13 1/4	5 15/16	<b>1,122.00</b>
ELU1317	11 1/2	15	7 1/2	<b>1,455.00</b>
ELU1618	16	18	9 1/2	<b>2,084.00</b>
ELU1716	16	17 1/2	7 1/2	<b>2,084.00</b>
ELU2118	21	18 5/8	7 1/2	<b>1,810.00</b>
ELU211810	21	18 5/8	10	<b>1,884.00</b>
ELU2421	20 3/8	18	6	<b>2,793.00</b>

The above listing represents standard die-drawn sinks. These have lower prices and shorter lead times than custom-fabricated sizes.

The above bowls can be rotated 90° from above lengths and widths when required.

Custom-fabricated bowl sizes are available. Contact your Elkay sales representative for more information.

Please see pages 6 and 7 for custom features available for sink tops.

# Custom Features Price Schedule

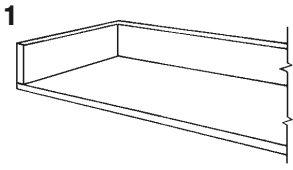

### ADD FOR EACH RETURN END

4" high .....	\$220.00
8" high .....	302.00
12" high .....	366.00
16" high .....	457.00

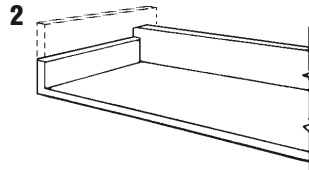

### LOWER/HIGHER BACKPLASH OR RETURN ENDS

Where return end is lower or higher than height of backplash of sink or counter top...in addition to charge for return end... add flat charge of.....**\$150.00**

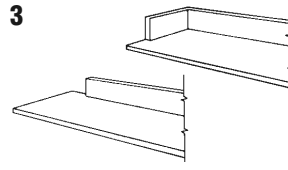

### SHORTER BACKPLASH OR RETURN ENDS

Where backplash or return end is shorter than sink length or width... add flat charge of.....**\$181.00**

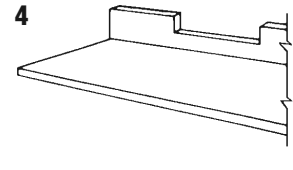

### FULL NOTCHING OF BACKPLASH

Full cutout of backplash as shown in this example... add flat charge of.....**\$313.00**

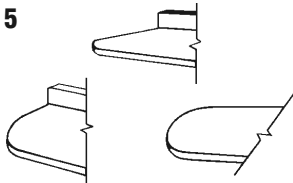

### OUTSIDE RADIUS CORNERS\*

Add the following flat charges to flat or raised rim tops:

	W/RIM	FLAT
Up to 1" radii .....	\$121.00	\$121.00
Over 1" to 3" radii .....	N/A	170.00
Add per inch over 3" radii .....	N/A	34.00
1/2" circle end, up to 15" radii .....	N/A	886.00

\*Not available with feature #17 or #7.

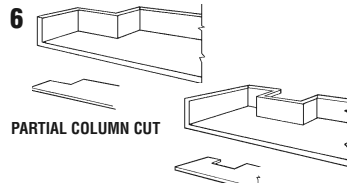

### PARTIAL COLUMN CUT

Add following flat charges for this condition:

Unit has no backplash .....	\$292.00
Unit has 4" back (or less) .....	392.00
Unit has back over 4" .....	582.00

### FULL COLUMN CUT

Add following flat charges for this condition:

Unit has no backplash .....	\$484.00
Unit has 4" back (or less) .....	691.00
Unit has back over 4" .....	992.00

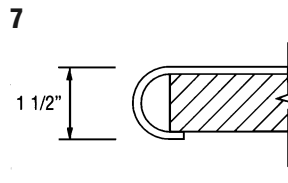

### BULL NOSE FRONT/SIDE EDGE OF TOP

Bull nose offered with 3/4" radius (1-1/2" Dia.) on front and/or sides in place of standard 1-1/2" turn down.

Bull nose is normally provided without a raised rim edge.

If required with standard 5/32" raised rim feature, bowls need to be located 4" from front and/or side edge of top.

In either above rim condition... add flat charge of.....**\$484.00**

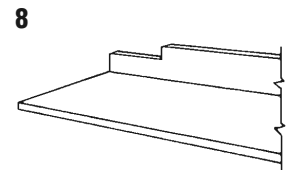

### PARTIAL NOTCHING OF BACKPLASH

Partial cutout of backplash as shown in this example... add flat charge of.....**\$235.00**

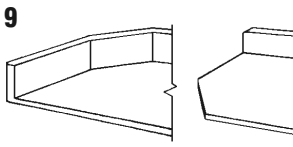

### OUTSIDE ANGLE CUTS

Following flat extra charge applied to flat or raised rim tops.

At corner where there is a backplash and/or return end .....**\$399.00**

At corner where there is NO backplash and/or return end .....**176.00**

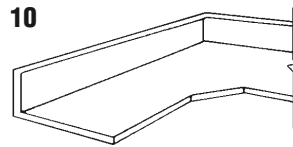

### INSIDE ANGLE CUTS

Following flat extra charge applied to flat or raised rim tops.

INSIDE "L" corner angle up to 6" long .....**\$484.00**

Add for each additional inch .....**.60.00**

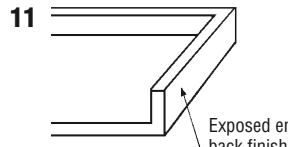

### FINISHED BACKPLASH

Finishing off exposed backs or ends up to 4" high by 26" in length (or less) add .....**\$542.00**

Each added inch of length .....**13.00**

Backs or ends over 4" and up to 8" by 26" in length (or less) add .....**625.00**

Each added inch of length .....**15.00**

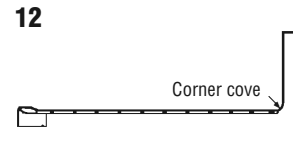

### COVED TYPE CORNERS

Coved corners where top surface meets backplash (and/or ends), 1/4" radius is standard (no extra charge).

1/2" or 3/4" radii at back only .....**\$248.00**

1/2" or 3/4" radii at each return end .....**126.00**

1/2" or 3/4" radii at each partial column cut .....**126.00**

1/2" or 3/4" radii at each full column cut .....**248.00**

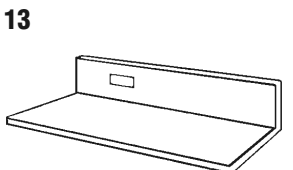

### ELECTRICAL CUTOUT

For cutting back with opening to receive one to four gang electric or switch box... add flat charge of .....**\$92.00**

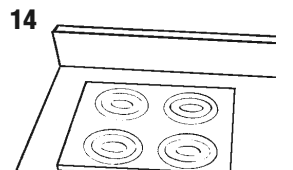

### DROP-IN RANGE OPENING

For cutting and reinforcing opening in top deck to receive rectangular gas or electric range... add flat charge of.....**\$382.00**

(Be sure to furnish manufacturer's name and complete model number)

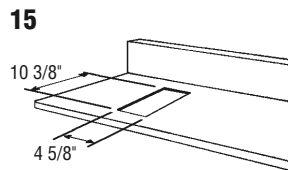

### NUTONE CUTOUT

Cutout top deck to receive NuTone power unit, location optional. (Be sure to provide clearance of 6 3/4" under counter area at this location)... add flat charge of.....**\$303.00**

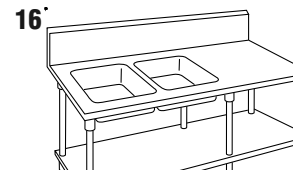

### UNDER SHELVES (#16-Gauge)

For use under drainboards arranged for bolting to support legs.

WHEN WIDTH IS:

Add for each linear foot { up to 27 1/2" **\$428.00 per ft.**  
 { 28" to 33 1/2" **556.00 per ft.**

Add for additional leg support as required, refer to #18.

## Custom Features Price Schedule

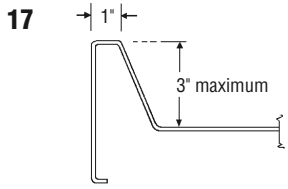

**HIGHER RAISED RIM\***  
Elkay standard raised rim is 5/32". Raised edges up to 3" can be supplied. Add for each linear foot.

Up to 1" high, per foot.....**\$52.00**  
1" to 2" high, per foot.....**58.00**  
2" to 3" high, per foot.....**64.00**

\*Not available with feature #5 or #7

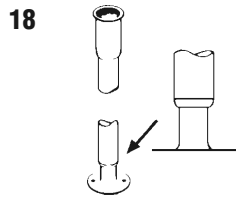

**LEG TYPE SUPPORTS**  
1 5/8" O.D. stainless steel tubing (up to 34 1/2" long)  
Each leg.....**\$283.00**  
34 1/2" leg places sink 36", floor to sink top rim). Gusset welded to steel under channel of top.

**Note: Add #20B steel channels for proper top support.**

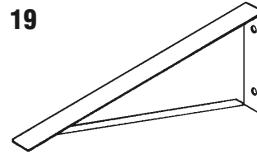

**SUPPORTING BRACKETS**  
#14 gauge stainless steel, angle type solid brackets, each.....**\$200.00**

**Note: Add #20B steel channels for proper top support.**

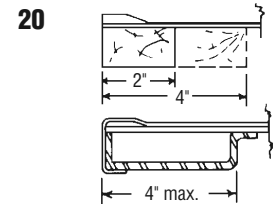

**SPECIAL WOOD FASTENING STRIPS OR STEEL CHANNELS**

**A.** Wood strips are supplied 2" wide as standard. Add for width over 2" up to 4", add per linear foot . . . **\$13.00**  
**B.** Steel channels (instead of wood) add for each linear foot required . . . **50.00**

Note: Channel support is provided to the front length, left and right widths, for tops over 96" in length, back length also needs to be supported.  
\*See #18 if legs req'd or #19 if brackets req'd.

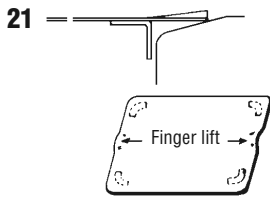

**SINK COMPARTMENT FLAT COVERS**  
Extra charge for each cover made of #16 gauge, polished stainless steel, for any size up to 20"x30" single compartment...  
add, per cover.....**\$638.00**

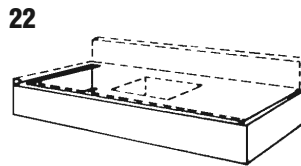

**APRONS FOR SINKS (#18 Gauge)**  
For adding 7" to 9" apron up to 48" length add flat extra charge of.....**\$486.00**  
Beyond 48" (including return ends) add for each additional linear inch.....**6.00**

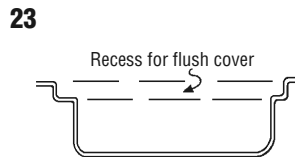

**RECESSING COMPARTMENTS FOR FLUSH MOUNT COVERS\***  
Where this feature is required add, as extra charge for recessing each compartment . . . . .**\$638.00**

\*Not available on oval and round bowls.

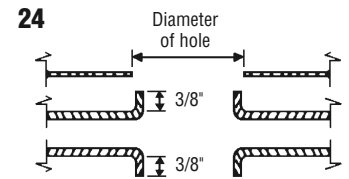

**SPECIAL ROUND OPENINGS**  
For each round opening cut-out up to 1 1/2" diameter, add . . . . .**\$38.00**  
Over 1 1/2" up to 6" diameter, add . . . . .**116.00**  
For each vandal proof type hole, add . . . . .**98.00**  
For each hole with 3/8" flange turned up or down, add . . . . .**236.00**  
(No extra charge for furnishing 1 1/2" diameter faucet openings.)

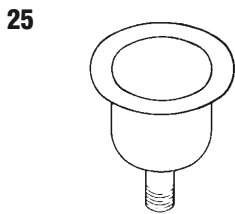

**CUP TYPE SINKS**  
Made of #16 gauge, type #316 stainless steel with 3/4" flange. 1 1/2" IPS, SS outlet, 2 1/4" long tailpiece.

4" dia. x 4" deep . . . . .**\$847.00**  
5" dia. x 4" deep . . . . .**880.00**  
6 1/2" dia. x 5" deep . . . . .**938.00**  
Above prices include cost of seamlessly welding each cup sink into countertops.

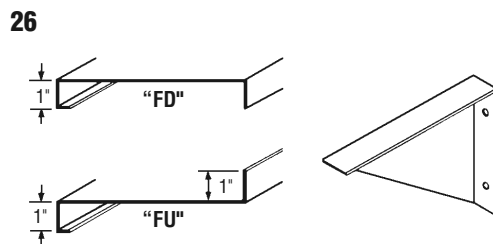

**STYLE "FD" AND STYLE "FU" SHELVING**  
Fabricated of #18 gauge, nickel bearing (18-8, type 304) stainless steel with flat rim. (Brackets extra).

	Shelf widths			
	6"	8"	10"	12"
Min, base-(up to 24" long)	<b>\$360.00</b>	<b>\$366.00</b>	<b>\$379.00</b>	<b>\$388.00</b>
Add for each inch of length	<b>10.00</b>	<b>13.00</b>	<b>13.00</b>	<b>14.00</b>
Brackets (#16 gauge St.St.)				
Each	<b>103.00</b>	<b>103.00</b>	<b>111.00</b>	<b>111.00</b>

(If #16 gauge shelving required, add 10% to above.)

### SPECIAL NOTES

#### Optional construction

#16 gauge top construction, with channel type reinforcing members, (less solid reinforcing plate feature) will be furnished at same price as #18 gauge when required.

#### Optional materials

Units may also be fabricated of Type 316 stainless steel. Price on application.

**How To Order Custom Scullery Sinks**

Custom Scullery Sinks are available as two standard Series and two standard Style designs.

**Series 8-14**

denotes sinks with 8-inch backsplash, 14-inch deep compartments.

**Series 12-12**

denotes sinks with 12-inch high backsplash, 12-inch deep compartments. (Backsplash height and compartment depth measured from top of channel rim.)

**Sink Styles:**

Style Numbers 8100, 8200, 8300 are *with* backsplash; Style Numbers 7100, 7200, 7300 are *without* backsplash.

**Series 8-14**

**8-inch high backsplash, 14-inch deep compartments**

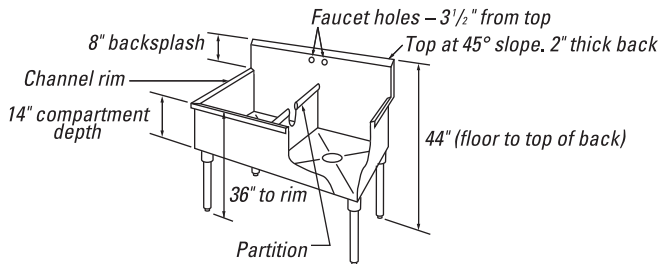

**Series 12-12**

**12-inch high backsplash, 12-inch deep compartments**

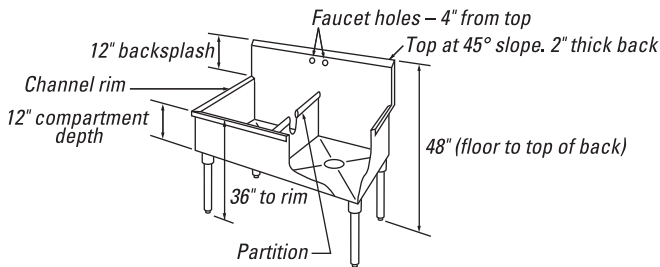

**Special Size Series**

If Series "8-14" or Series "12-12" will not meet your requirements . . . use depth chart below to select and specify sink size to meet your conditions.

"A" is compartment depth measured from top of channel rim to bottom of compartment. "B" is depth measured from top of partition to bottom of compartment. "C" is depth measured from drainboard level to bottom of compartment. "D" is height of backsplash measured from top of channel rim.

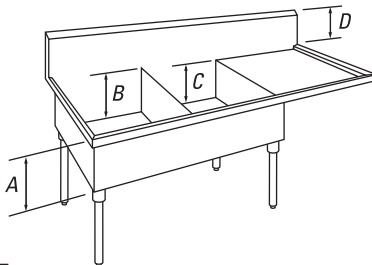

**DEPTH CHART**

	IF "A" IS	"B" IS	"C" IS	"D" IS
Specify	12-in.	11 1/2-in.	10-in.	Height
and	14-in.	13 1/2-in.	12-in.	of
order	16-in.	15 1/2-in.	14-in.	backsplash
by	18-in.	17 1/2-in.	16-in.	to
Depth	20-in.	19 1/2-in.	18-in.	be
at "A"	22-in.	21 1/2-in.	20 in.	specified

**Standard Equipment**

Standard equipment for all scullery sinks (standard or custom, not incl. MN-Series) includes: Set of four (4) tubular legs with adjustable bullet shaped feet.

Series "8-14" and Series "12-12" sinks have universal drain openings. Custom made units supplied with faucet hole locations as specified.

**Custom Made Units**

1. Select *construction quality* line desired:  
Refer to Full Line Commercial Sink Catalog for complete description and specifications of each quality grade.
2. Select Sink *Style Number*. (Style 8100, 8200, 8300 with backsplash. Style 7100, 7200, 7300 without backsplash).
3. State *inside length and width* of each sink compartment. Indicate length measurement first. (Length is left to right. Width is front to back.)
4. State *depth*. Compartment depth is measurement from top of channel rim to bottom of compartment. (See depth chart left.)
5. State *backsplash height*. Measure from top of sink rim to top of backsplash.
6. Specify *faucet holes and location*.
7. Specify *drain size and location*. If none specified, we supply 3 1/2" opening in compartment center.
8. State *drainboard* requirements, i.e., overall length of each, whether integral or detachable type, located on right or left side or on both sides.
9. State *special features* requirements.
10. Select *fitting and accessories*. An accurate dimensional sketch of your special sink requirements will help to expedite your order.

**How To Price**

Sink Style 8100, single compartment with backsplash and less drainboard, in either Series "8-14" or Series "12-12", is used as the base for all pricing. (See Basic Price Schedule, top of page 9.)

Start with the cost of this basic sink unit, ADDING all other charges.

**Single Compartment—Style 8100**

Price of basic single compartment sink is determined by inside length of compartment. Select price shown for appropriate inside length. (See top of Page 9.)

**Double Compartment—Style 8200**

Price of basic double compartment sink is determined by adding inside lengths of both (2) compartments. To List Price appropriate to this TOTAL inside length measurement:

. . . Add extra charge for one partition.

Note: Partition may be placed in any location.

**Triple Compartment—Style 8300**

Price of basic triple compartment sink is determined by adding inside lengths of each (3) compartments. To List Price appropriate to this TOTAL inside length measurement:

. . . Add extra charge for two partitions.

Note: Partition may be placed in any location.

**Drainboard Pricing**

Integral type drainboards are available up to 120" long. Drainboards longer than 24", but less than 48", are supplied with (1) support leg. Over 48", with (2) support legs. (Support legs included in list price.)

**Custom Special Features**

Custom special features are optional and are listed as extra charges to be added to price of basic sink unit. (See list on Pages 10 and 11.)

**NOTES:**

To determine overall dimensions of sink:

**LENGTH. (Left to right measurement.)**

1. For sink without drainboard, add 3" to inside compartment length, i.e., 48" sink would measure 51" overall. (Each side channel rim is 1 1/2")
2. For sink with one drainboard, add length of drainboard to compartment length plus 1 1/2" for exposed rim of sink, i.e., 48" sink with (1) 24" drainboard would measure 73 1/2" overall.
3. For sink with two drainboards, add length of both drainboards to compartment length, i.e., 48" sink with (2) 24" drainboards would be 96" overall.

**WIDTH. (Front to back measurements.)**

1. Add 3 1/2" to inside compartment width, i.e., 24" compartment width would measure 27 1/2" overall. (Includes 2" for backsplash thickness, 1 1/2" for thickness of front channel rim.)

**Schedule A—Single Compartment Sinks . . . With Backsplash—Sink Style 8100**



Price schedule (below) is based upon Sink **Style 8100**, Single Compartment, in either Series 8-14 or Series 12-12, less drainboards and in sizes shown. For pricing in-between sizes, use price of next larger size. Sinks are made of #14 gauge, Type 304 stainless steel.

Add all other charges (Schedule B or C, and/or D, and/or Custom Features on Pages 10 & 11) to below base price of sink. Price shown includes (4) LK251 stainless steel tubular support legs with adjustable bullet shaped feet (or (4) LK251F with adjustable flanged feet). **Wall brackets can be provided in lieu of legs at no additional charge.**

INSIDE COMPARTMENT SIZE, IN INCHES		SERIES "8-14" 8" BACKSLASH	OR	SERIES "12-12" 12" BACKSLASH	STAINLESS STEEL SINKS			
LENGTH	WIDTH				DEPTH	DEPTH	SHIP. WT. LBS.	SSC PREFIX SQUARE CORNER SUGGESTED LIST PRICE
15	24	14		12	85	\$2,294.00	\$2,508.00	\$3,297.00
18	24	14		12	90	2,421.00	2,635.00	3,480.00
20	24	14		12	95	2,505.00	2,719.00	3,573.00
24	24	14		12	100	2,676.00	2,889.00	3,758.00
30	24	14		12	115	2,942.00	3,156.00	4,063.00
36	24	14		12	130	3,133.00	3,260.00	4,316.00
42	24	14		12	145	3,309.00	3,517.00	4,597.00
45	24	14		12	150	3,435.00	3,644.00	4,737.00
48	24	14		12	160	3,564.00	3,771.00	4,878.00
54	24	14		12	170	3,866.00	4,072.00	5,211.00
60	24	14		12	185	4,161.00	4,369.00	5,535.00
66	24	14		12	200	4,526.00	4,734.00	5,937.00
72	24	14		12	215	4,892.00	5,085.00	6,338.00
†† 78	24	14		12	230	5,822.00	6,030.00	7,305.00
†† 81	24	14		12	235	6,008.00	6,217.00	7,510.00
†† 90	24	14		12	260	6,561.00	6,768.00	8,119.00
†† 96	24	14		12	270	6,926.00	7,132.00	8,518.00

†† Furnished with (6) LK251 stainless steel tubular legs

**Schedule B—Double Compartment Sinks with Backsplash**

**Style 8200**, Sink with backsplash, less drainboards. Add inside lengths of each compartment. Select appropriate price for this total length from above single compartment Schedule A...

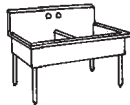

...AND ADD THIS EXTRA CHARGE FOR ONE PARTITION

DEPTH	LBS.	SSC PREFIX	LBS.	WCNSF PREFIX	LBS.	CNSF PREFIX
12" or less	7	\$742.00	7	\$1,066.00	14	\$1,726.00
12 1/2" to 14"	8	808.00	8	1,215.00	16	2,022.00

**Schedule C—Triple Compartment Sinks with Backsplash**

**Style 8300**, Sink with backsplash, less drainboards. Add inside lengths of each compartment. Select appropriate price for this total length from above single compartment Schedule A...

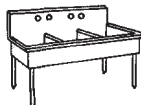

...AND ADD THIS EXTRA CHARGE FOR TWO PARTITIONS

DEPTH	LBS.	SSC PREFIX	LBS.	WCNSF PREFIX	LBS.	CNSF PREFIX
12" or less	14	\$1,483.00	14	\$2,134.00	28	\$3,450.00
12 1/2" to 14"	16	1,616.00	16	2,432.00	32	4,045.00

**Schedule D—Integral Type Drainboards with Backsplash**

Price for drainboards longer than 25 1/2 inches includes one (1) support leg. Price for drainboards longer than 48 inches includes two (2) support legs.

Note: (1.) Drainboard length includes 1 1/2 inch rim.  
(2.) NSF code type sink does not permit use of bracket support.

Add appropriate price for each drainboard to price of basic sink unit.

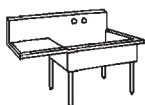

Style 8100L (Integral Drainboard On Left End)

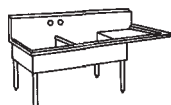

Style 8200R (Integral Drainboard On Right End)

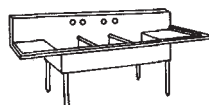

Style 8300LR (Integral Drainboard On Right and Left End)

WITH BACKSLASH NOT OVER 8 INCHES HIGH			WITH BACKSLASH OVER 8 INCHES BUT NOT OVER 12 INCHES HIGH		
EACH DRAINBOARD LENGTH	SHIP. WT. LBS.	LIST PRICE	EACH DRAINBOARD LENGTH	SHIP. WT. LBS.	LIST PRICE
12 in.	20	\$ 727.00	12 in.	32	\$ 762.00
15 in.	25	814.00	15 in.	37	838.00
18 in.	30	934.00	18 in.	36	967.00
20 in.	40	1,008.00	20 in.	47	1,044.00
24 in.	45	1,158.00	24 in.	53	1,195.00
25 1/2 in.	50	1,230.00	25 1/2 in.	60	1,083.00
30 in.	55	1,370.00	30 in.	65	1,429.00
36 in.	70	1,479.00	36 in.	77	1,654.00
42 in.	80	1,770.00	42 in.	89	1,849.00
48 in.	90	1,963.00	48 in.	101	2,054.00
54 in.	105	2,413.00	54 in.	117	2,497.00

Drainboards longer than 54 inches see page 11, item 9 for additional cost.

**SEE PAGES 10 AND 11 FOR CUSTOM FEATURES**

These custom features are for scullery sinks priced as custom on page 9. To modify any of the standard catalog sinks, the sink first needs to be priced as a custom on page 9, then add for these custom features.

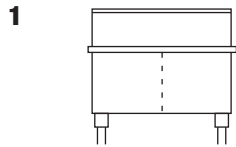

### 1 SSC- PREFIX: DEEPER COMPARTMENTS

For units with up to an 8" high backsplash – **ADD** for extra depth on compartment(s) over 14" deep, up to 24" deep.

For units with over an 8" high backsplash – **ADD** for extra depth on compartment(s) over 12" deep, up to 24" deep.

**ADD** for each extra inch of depth\*

Single . . .	<b>\$118.00</b>
Double . . .	<b>156.00</b>
Triple . . .	<b>189.00</b>

\* Maximum depth allowed is 24". Contact Elkay Representative if deeper than 24" is needed.

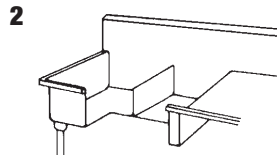

### 2 WCNSF- /CNSF- PREFIX: DEEPER COMPARTMENTS WITH COVE CORNERS

For units with up to an 8" high backsplash – **ADD** for extra depth on compartment(s) over 14" deep, up to 24" deep.

For units with over an 8" high backsplash – **ADD** for extra depth on compartment(s) over 12" deep, up to 24" deep.

Prefix	Prefix
WCNSF-1/4"	CNSF-3/4"
Cove Series	Cove Series

**ADD** for each extra inch of depth

Single . . .	<b>\$142.00</b>	Single . . .	<b>\$208.00</b>
Double . . .	<b>202.00</b>	Double . . .	<b>337.00</b>
Triple . . .	<b>258.00</b>	Triple . . .	<b>459.00</b>

\* Maximum depth allowed is 24". Contact Elkay Representative if deeper than 24" is needed.

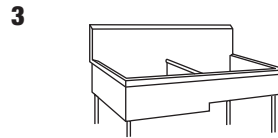

### 3 DEPTH VARIATION

Sink with one compartment shallower or deeper than the other. **ADD** to base sink price for each depth variation.

Flat charge of . . . . . **\$682.00**

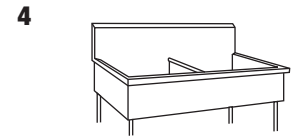

### 4 A. WIDER COMPARTMENT(S)

Compartments wider than standard 24" inside dimension width:

**ADD** for each extra inch of width up to 36" wide\*

Single . . .	<b>\$69.00</b>
Double . . .	<b>84.00</b>
Triple . . .	<b>104.00</b>

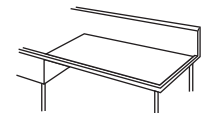

### B. WIDER DRAINBOARD(S)

Integral drainboards (with or without backsplash) or detachable type, wider than standard 27 1/2" overall dimension, front to back.

WHEN LENGTH IS:

**ADD** for each extra inch of width up to 36" wide\*

3" to 48"	<b>\$38.00</b>
over 48" to 60"	<b>58.00</b>
over 60" to 78"	<b>78.00</b>

Beyond 36" – Price on application.

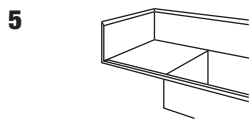

### 5 RETURN ENDS

Up to 8" high return end:

**ADD** for each return end . . . **\$483.00**

Over 8" up to 12" high return end:

**ADD** for each return end . . . **\$495.00**

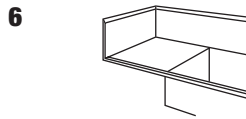

### 6 HIGHER RETURN ENDS

For compartment(s) up to 12" deep, return end can be up to 12" high at No. 5 12" return end price.

For compartment(s) over 12" deep, return end can be up to 8" high at No. 5 8" return end price.

For each extra inch of height beyond the above standards – **ADD– \$24.00 per linear foot.**

(Maximum height allowed is 21". Contact Elkay Representative if higher than 21" is needed.)

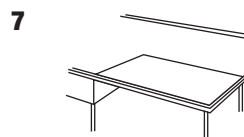

### 7 HIGHER BACKSPASH

For compartment(s) up to 12" deep, backsplash can be up to 12" high at no additional charge.

For compartment(s) over 12" deep, backsplash can be up to 8" high at no additional charge.

For each extra inch of height beyond the above standards – **ADD– \$24.00 per linear foot.**

(Maximum height allowed is 21". Contact Elkay Representative if higher than 21" is needed.)

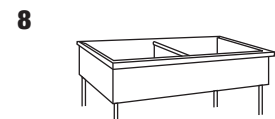

### 8 NO BACKSPASH

(Style 7100, 7200, 7300)

#### Series 8-14

Deduct for omission of backsplash **\$70.00**. ft. 2 Lbs./Ln. ft.

#### Series 12-12

Deduct for omission of backsplash **\$82.00**. ft. 3 Lbs./Ln. ft.

Units without any backsplash may require H-frame support. Consult with local Elkay Representative. Unit will have 1 1/2" channel rim on all four sides.

**NOTE: For sink dimensions in fractions of an inch, round up to next full inch or foot to calculate price.**

These custom features are for scullery sinks priced as custom on page 9. To modify any of the Weldbilt® or Sturdibilt® sinks, the sink first needs to be priced as a custom on page 9, then add for these custom features.

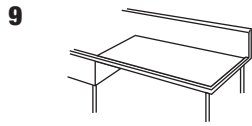

### 9 LONGER DRAINBOARDS\*

Integral or detachable type over 54" long. (Standard 24" inside dimension width.) Use base price of 54" drainboard, page 9 and...**ADD**

for each extra inch†	Without backsplash	<b>\$26.00</b>
over 54"	With 8" backsplash	<b>30.00</b>
	With 12" backsplash	<b>32.00</b>

\* Also add for additional support legs as required, refer to No. 11.

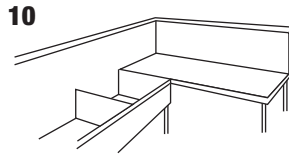

### 10 SPECIAL "L" OR "U" SHAPED DRAINBOARDS

For hairline seam field joint or welded seamless:

Without backsplash, **ADD . . . \$858.00**  
With backsplash, **ADD . . . . . 1,080.00**

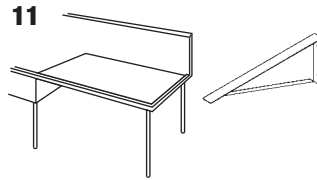

### 11 A. ADDITIONAL SUPPORT LEGS

**ADD** for each support leg every 48" LK251 1 5/8" O.D. stainless steel tubular leg w/bullet foot . . . . . **\$283.00**  
LK251F 1 5/8" O.D. stainless steel tubular leg w/flanged foot . . . . . **\$283.00**

### B. ADDITIONAL SUPPORTING BRACKETS

#14 gauge stainless steel, solid brackets, add for each support bracket every 48" . . . . . **\$200.00**

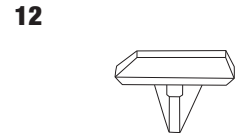

### 12 SSCD - DETACHABLE TYPE DRAINBOARDS WITHOUT BACKSPLASH

Price based on standard 24" width inside dimension (front to back). Hemmed edges, 2" high. Drainboards up to and including 24" long include bracket support for securing drainboard to scullery sink. Drainboards over 24" long include (2) LK251 stainless steel support legs.

Overall length	
18" - 23 lbs.	<b>\$1,018.00</b>
24" - 28 lbs.	<b>1,092.00</b>
30" - 40 lbs.	<b>1,164.00</b>
36" - 45 lbs.	<b>1,237.00</b>

For pricing in between sizes, use price of next larger size.

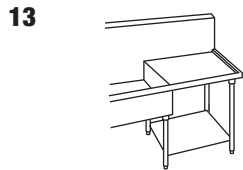

### 13 UNDER SHELVES (#16 GAUGE)\*

For use under drainboards or compartment arranged for bolting to support legs.

<b>ADD</b> for each lineal foot*	WHEN WIDTH IS:	
	up to 27 1/2"	<b>\$428.00</b>
	28" to 33 1/2"	<b>556.00</b>

\* Also add for additional support legs as required, refer to No. 11.

NOTE: Width is front to back.

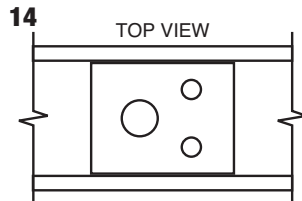

### 14 ARRANGEMENT FOR HATCO HEATER

Minimum compartment length:

For **3CS3** 15" **ADD . . . . . \$214.00**  
For **3CS4** 16"-18" **ADD . . . . . 214.00**  
For **3CS9** 24" **ADD . . . . . 214.00**

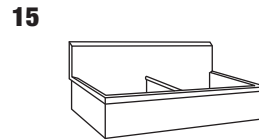

### 15 NO SINK SUPPORTS

Where sinks are required without support legs. (Gussets will also be omitted unless otherwise specified.)

Deduct from basic sink price . . . . . **\$312.00**

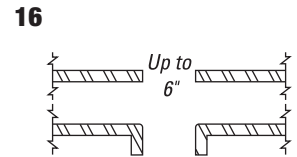

### 16 GARBAGE OPENINGS - PLAIN AND NSF

Drainboards required with garbage cutout:

Round plain, 6" diameter, without flange: **ADD** for each opening . . . . . **\$121.00**

Round plain, 6" diameter, with 1/2" flange down (NSF requirement): **ADD** for each opening . . . . . **\$243.00**

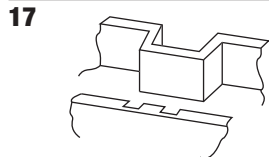

### 17 PIPE CHASE OR COLUMN CUTOUTS

Drainboards without backsplash:

**ADD** for partial cutout . . . . . **\$446.00**  
**ADD** for full cutout . . . . . **786.00**  
Notching in thickness of back only, **ADD** . . . . . **128.00**

Drainboards with backsplash:

**ADD** for partial cutout . . . . . **657.00**  
**ADD** for full cutout . . . . . **1,125.00**

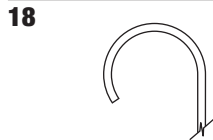

### 18 ROLL RIM IN LIEU OF CHANNEL RIM

If 1 1/2" or 1 1/4" rolled rim is required in place of standard 1 1/2" channel rim, price sink as custom (page 9).

No extra charge for roll rim.

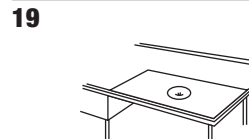

### 19 CONES FOR COMMERCIAL WASTE DISPOSERS\*

Weld in cone feeder for commercial disposer units:

**ADD** for 12" diameter . . . . . **\$602.00**  
**ADD** for 15" diameter . . . . . **649.00**  
**ADD** for 18" diameter . . . . . **694.00**

\* Cones supplied by customer when order is placed with Elkay

Also add for additional support legs as required, refer to No. 11.

NOTE: For sink dimensions in fractions of an inch, round up to next full inch or foot to calculate price.

## TERMS AND CONDITIONS

### Pricing

All prices and product specifications are subject to change without notice. Prices are F.O.B. factory. No freight allowance.

### Taxes

All Federal, State or Local Taxes when appropriate to be added.

### Electronic Data Interchange (EDI)

Elkay supports the following EDI transaction sets: Inbound Purchase Orders (850), Outbound Invoices (810), Advanced Ship Notice (856), Inbound Remittance Advice (820) and Outbound Order Acknowledgement (855). Please contact Elkay's EDI Coordinator at (630) 574-8484 to discuss the list of current transaction set versions and your implementation requirements.

### Cancellation

On custom made models designed to customer's specifications, an engineering charge will be assessed if order is cancelled before fabrication has commenced. If cancellation is after fabrication is started, cancellation charge will be dependent on extent of work performed.

### Return Goods

No returns allowed on custom made products.

### Limited Warranty

All Elkay products are warranted to be free from manufacturing defects. If item is defective due to faulty materials or workmanship, a new item or like type and size will be supplied. (This warranty does not cover installation charges.)

### Loss and/or Damage in Transit

Our liability ceases upon delivery of the goods to the carrier at our factory. Claims for damage and/or loss in transit to be made by the consignee against the carrier. We will assist and cooperate in the processing of such claims upon customer's request.

### Payment Terms

As standard.

### ARCHITECTURAL SPECIFICATIONS

Custom made stainless steel sink tops and countertops shall be of sizes and dimensions as shown on plans, and be as manufactured by ELKAY MANUFACTURING COMPANY, Broadview, Illinois and shall be fabricated as follows:

Shall be made of #18 gauge, Type 304, 18-8 stainless steel bonded to and reinforced with #14 gauge steel plate welded to 3/4"x3/4"x1/8" angle iron. 1 1/2" thick wood strips provided for fastening to cabinets. One-piece construction of drainboards, rims, back and return end/s with intersections of 1/4" radius. Drainboards with fan-shaped drain area. Sink bowls with 1 3/4" radius for horizontal and vertical corners integrally and seamlessly welded into top. Overlapping or soldered edges not permitted. Underside sound-deadened. Exposed surfaces blended to an Elkay satin finish.

*In keeping with our policy of continuing product improvement, Elkay reserves the right to change product specifications without notice.*

# **ELKAY**<sup>®</sup>

2222 Camden Court  
Oak Brook, IL 60523  
(630) 574-8484

[elkayusa.com](http://elkayusa.com)