

Installation Instructions

sinks + faucets

E-Granite™ Sink

- **READ THESE INSTRUCTIONS THOROUGHLY BEFORE YOU BEGIN.**
- **Follow all local plumbing and building codes.**
- **Before installation, please inspect the sink for damage. Do not install a damaged sink.**
- **For drop-in sinks go to section I. For undermount sinks go to section II.**

I. DROP-IN INSTALLATION

Note: The clips provided are designed for a maximum counter-top thickness of 1-3/4".

1. To determine the proper size opening for your sink place the sink upside down on top of the countertop. Mark or trace a line around the edge of the rim. Then cut a hole 5/16" inside this line all around. (See illustration A)
2. Set new sink in opening to see that it fits properly.
3. **Faucet Holes:** Faucet holes can be identified by the faucet hole emboss on the underside of the faucet deck and the corresponding adhesive dots located on the faucet deck top surface. Before punching the holes please verify that the adhesive dots are properly centered over the faucet hole emboss. The faucet hole should be carefully penetrated from above the sink using a chisel or screw driver and tapping lightly on the adhesive dots. (See illustration B). If necessary the hole can be enlarged using a metal hole saw, a jigsaw with a metal cutting blade or a metal file. Note: Support faucet deck while punching faucet holes.
4. Attach faucet, drain fittings and accessories according to the manufacturer's instructions.

5. See illustration C for sink model ELGS3019 overflow installation instructions. Follow all local plumbing and building codes.
6. As shown in illustration D and E, align clips with the corresponding holes in the sinks and gently push into place. Push plastic pins on the clips inward completely so that the clip expands and engages the sink. Note that it may be necessary to use a nail punch and hammer to push pin in completely. Make sure metal portion of the clip (clamp) is in the open position so that sink can be dropped into cutout.
7. Apply a bead of a high quality silicone adhesive caulk to the underside of the sink rim and position sink into countertop opening. CAUTION: Use only a high quality silicone adhesive caulk.
8. Swing metal portion of clip (clamp) into the clip base, until it clicks into place. Using a phillips screwdriver, turn screw until clamp engages the countertop.
9. Remove excess caulk and allow caulk to cure following the caulk manufacturer's instructions.

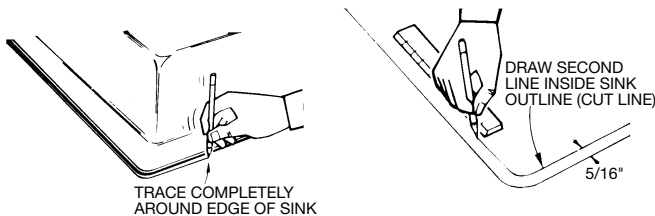

ILLUSTRATION A

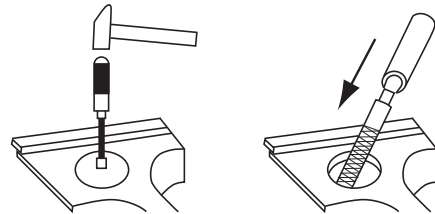

ILLUSTRATION B

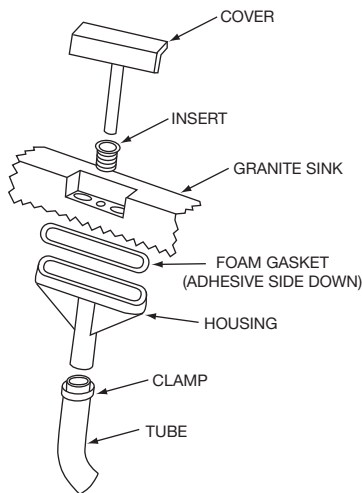

ILLUSTRATION C

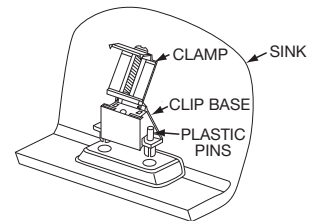

ILLUSTRATION D

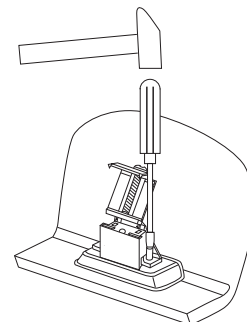

ILLUSTRATION E

II. UNDERMOUNT INSTALLATION

ATTENTION INSTALLER:

- **ELKAY RECOMMENDS THAT UNDERMOUNT SINKS SHOULD BE INSTALLED BY A PROFESSIONAL EXPERIENCED INSTALLER.**
- **WARNING: THE ENCLOSED CUTOUT TEMPLATE PROVIDES A SINK OPENING THAT WILL EXPOSE APPROXIMATELY 1/8" OF SINK RIM LEDGE AS SHOWN IN ILLUSTRATION F AND G.**
- **IT IS RECOMMENDED THAT YOU DISCUSS WITH YOUR CUSTOMER AND AGREE TO WHAT THE FINISHED EFFECT WILL BE. ELKAY IS NOT RESPONSIBLE FOR IMPROPER SINK OR COUNTERTOP INSTALLATIONS.**
- **ELKAY E-GRANITE UNDERMOUNT SINKS MUST BE FASTENED TO SOLID SURFACE COUNTERTOPS ONLY (I.E. GRANITE).**
- **ELKAY IS NOT RESPONSIBLE FOR SINK AND COUNTERTOP IF DAMAGED DURING INSTALLATION.**
- **FOLLOW ALL LOCAL PLUMBING AND BUILDING CODES.**

1. Position template on countertop. Locate front to rear, so sink will not interfere with the cabinet.
2. Trace a line around the template. Cut along the inside of this line to provide opening.
3. Locate and provide for the mounting holes (following the countertop manufacturer's instructions). Holes should allow for even spacing around sink. Type of fasteners to be as recommended by countertop supplier.
4. Fasten mounting brackets to countertop loosely.
5. Using a high quality silicone adhesive caulk, apply a bead evenly all around the top of the sink flanges.
6. Position and align the sink in the countertop opening.
7. Tighten fasteners until mounting brackets are snug against sink.
8. Check alignment of sink to countertop opening.
9. Tighten down fasteners evenly. **Be careful not to over-tighten.** Remove excess caulk and allow caulk to cure following the caulk manufacturer's instructions.

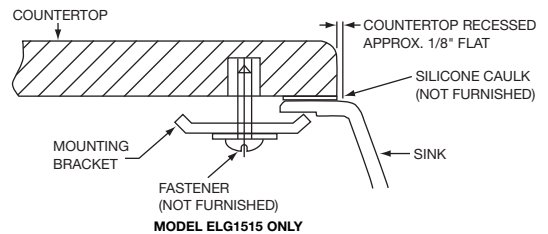

ILLUSTRATION F

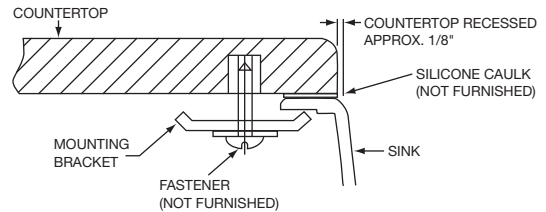

ILLUSTRATION G

CARE AND CLEANING GUIDE

Elkay E-Granite was created for a lifetime of easy care. Just follow the simple guidelines listed below.

Routine Care

Most dirt and stains: Use soapy water and a sponge, towel dry.

Water marks: Wipe with damp cloth and towel dry.

Difficult stains: 50/50 water/bleach solution or non-abrasive cleaners. Follow cleaning manufacturer's instructions, rinse thoroughly, towel dry.

Preventing Damage

- Avoid exposing Elkay E-Granite to strong chemicals, such as paint removers, oven cleaners, etc. If contact occurs, quickly flush the surface with water. Do not use a straight or undiluted bleach solution.
- Do not set hot pans directly into sinks
- Run cold water when pouring boiling water into sinks.
- Do not use any abrasive cleaning products, scouring pads or steel wool.
- Do not use caustic solutions containing ammonia or alkalis.

ELKAY LIMITED LIFETIME E-GRANITE SINK WARRANTY

Elkay warrants to the original purchaser of an Elkay E-Granite sink that Elkay will, at its option, replace or repair, without charge, such product if it fails due to a manufacturing defect for a lifetime of normal residential use. Product replacement does not include transportation cost or labor installation cost. This warranty covers only E-Granite drop-in sinks installed in a conventional countertop surface and E-Granite undermount sinks installed in a conventional solid surface countertop and applies to residential installations only. Elkay reserves the right to examine product in question and its installation prior to replacement.

WASTE FITTINGS AND ACCESSORIES ARE NOT WARRANTED OTHER WARRANTY CONDITIONS ON SINKS

This warranty applies to sinks purchased after August 1st 2007 as shown on the purchaser's dated receipt. Our warranty does not cover product failure or damage caused by abusive treatment, misuse, environmental factors, normal wear including dents and scratches, improper care and cleaning, use of aggressive and abrasive cleaners, damage due to handling or failure to follow the recommended procedures for installation, care and maintenance as detailed in the installation and care guide provided with every sink. This warranty is extended only to the original consumer purchaser of the product. This warranty does not cover shipping costs, labor costs, or any other charges for such items as installation or replacement of the sink, diagnosis or replacement of any faucet or component part, or any other expense or loss.

All incidental or consequential damages are specifically excluded. No additional warranties, express or implied are given, including but not limited to, any implied warranty of merchantability or fitness for a particular purpose.

Some states do not allow the exclusion or limitation of incidental or consequential damages or limitations on how long an implied warranty lasts, so the above limitations or exclusions may not apply to you.

This warranty gives you specific legal rights, and you may also have other rights which vary from state to state.

TO OBTAIN SERVICE UNDER WARRANTY

1. In the USA, write to:
Elkay Manufacturing Company
Attention: Consumer Services
2222 Camden Court
Oak Brook, IL 60523
- In Canada, please contact /
Au Canada, pour toute demande
de garantie, veuillez contacter:
ELKAY Canada Ltd
7000 Pine Valley Drive, Unit 102
Vaughan, Ontario L4L 4Y8
2. Include a letter containing the following information:
 - a. Date of purchase and installation
 - b. Proof of Purchase (copy of original dated invoice)
 - c. Description of nature of defect
 - d. Model number or description of model and/or component part if possible.